

ECLIPSE SERIES

User Manual

GP-ECLIPSE-190

GP-ECLIPSE-FLEX-190

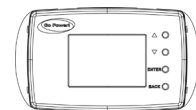
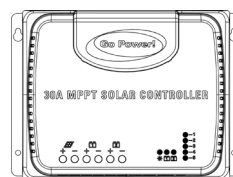
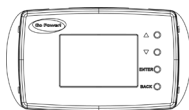
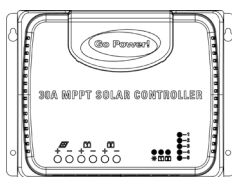
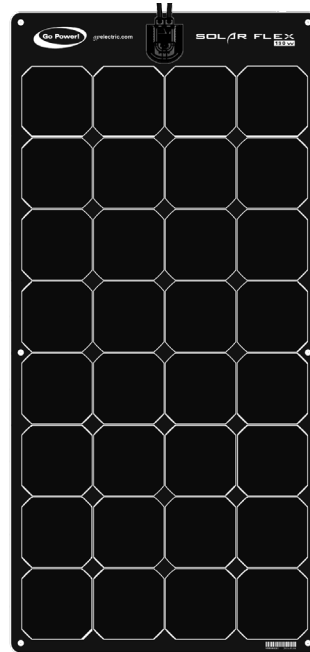
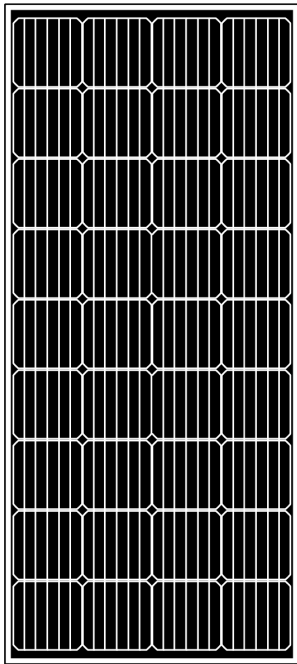

RIGID

FLEX

© 2021 Go Power!

Worldwide Technical Support and Product Information gpelectric.com

Go Power! | Dometic

201-710 Redbrick Street Victoria, BC, V8T 5J3

Tel: 1.866.247.6527

MAN_ECLIPSE_190W_RevA-DOMPGR



Congratulations on purchasing your Go Power! Eclipse Kit

Record the unit's model and serial number below. It is much easier and quicker to record this information now at the pre-installation stage.

Model Number:

Serial Number:

Date of Install:

Battery Bank Information: (size, install date, battery type)



Product Packaging

Please safely store the packing the IC Series was delivered in or recycle the packaging components as outlined below:



Corrugated fiberboard
main box

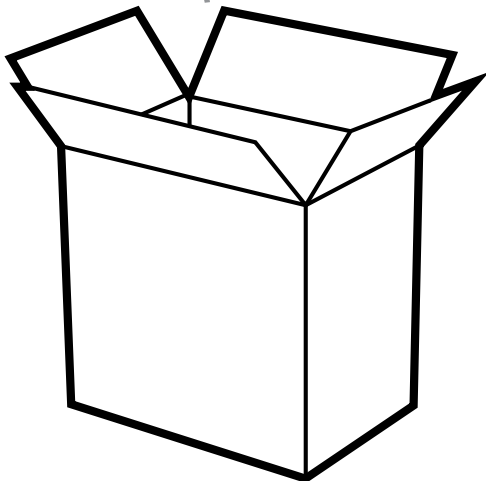

Plastic
foam protection

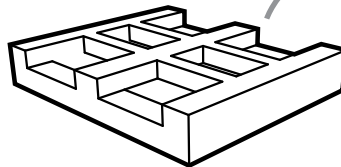

LDPE
Low Density
Polyethylene



Plastic
accessories bag

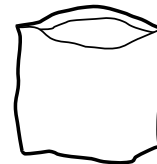

Local recycling centers can be found here:
www.earth911.com/recycling-center-search-guides

2.	GENERAL INFORMATION	4
2.1	HOW DOES A GO POWER! RV SOLAR CHARGING KIT WORK?	4
2.2	CAUTIONS.....	6
2.3	DISCLAIMERS.....	7
2.4	KIT PARTS.....	7
2.5	TOOLS REQUIRED.....	9
3.	PLANNING LOCATIONS.....	10
3.1	PLAN YOUR SOLAR SYSTEM SETUP.....	10
3.2	PLACEMENT OF SOLAR PANELS	10
3.3	GP-RVC-30-MPPT SOLAR CHARGE CONTROLLER.....	10
4.	INSTALLATION.....	11
4.1	SOLAR PANELS	11
4.2	REFRIGERATOR VENT ACCESS 1.....	13
4.3	REFRIGERATOR VENT ACCESS 2.....	13
4.4	CABLE ENTRY PLATE.....	14
4.5	MOUNTING FEET.....	14
4.6	INSTALLING THE SOLAR CHARGE CONTROLLER	14
4.7	INSTALLING THE 30A FUSE AND FUSE HOLDER.....	15
4.8	CONNECTING GP-PWM-30 TO BATTERY BANK	15
4.9	INITIAL CONNECTION AND OPERATING / BATTERY BANK CONFIGURATIONS	15/16
5.	MAINTENANCE	16
6.	WARRANTY.....	17

Congratulations on purchasing your Go Power! RV Solar Kit. You have chosen a clean, quiet and sustainable power source. Go Power! Solar RV Kits allow you to power appliances in your RV, without hooking up to shore power or a noisy generator. Go Power! Solar RV kits will keep your batteries charged, ensuring you have power when you need it.

This mobile DC power system allows you to enjoy the luxuries that electricity provides, without a campsite hookup. For simple battery maintenance or full-time live-aboard power, Go Power! RV Solar Power Kits are available in a variety of sizes and can be installed on RVs, campers, trailers, fifth wheels and motor homes. As with any off-grid power systems, the user is required to manage electrical loads to ensure continual power availability for essential services. Your location and season (hours of sunlight available) play a role in how much energy can be harnessed from this kit.

Note This manual will aid in the process of installing the Go Power! Solar RV Kit. Please read and understand this manual and all included manuals before installing the Go Power! Solar RV Kit. Review all diagrams included in this guide for the easiest and safest installation. **Please retain this manual for future reference.**

2.1 HOW DOES A GO POWER! SOLAR CHARGING KIT WORK?

The solar panel converts the sun's energy into DC electricity and this electricity charges the battery. The battery stores the electricity, similar to a water tank storing water. This battery power may be used at any time to operate DC powered devices connected to the battery. To increase the battery service life, a solar controller is used to prevent the solar panels from overcharging the batteries. This process is managed by the GP-RVC-30-MPPT Solar Charge Controller included in this kit. See Figure 2-A (below) and 2-B (on following page) for solar system examples.



WARNING: When connecting multiple panels, they will be connected in **PARALLEL**. Failure to follow this connection procedure will cause the system to produce large currents which the protection device, DC fuse, is not designed to handle.

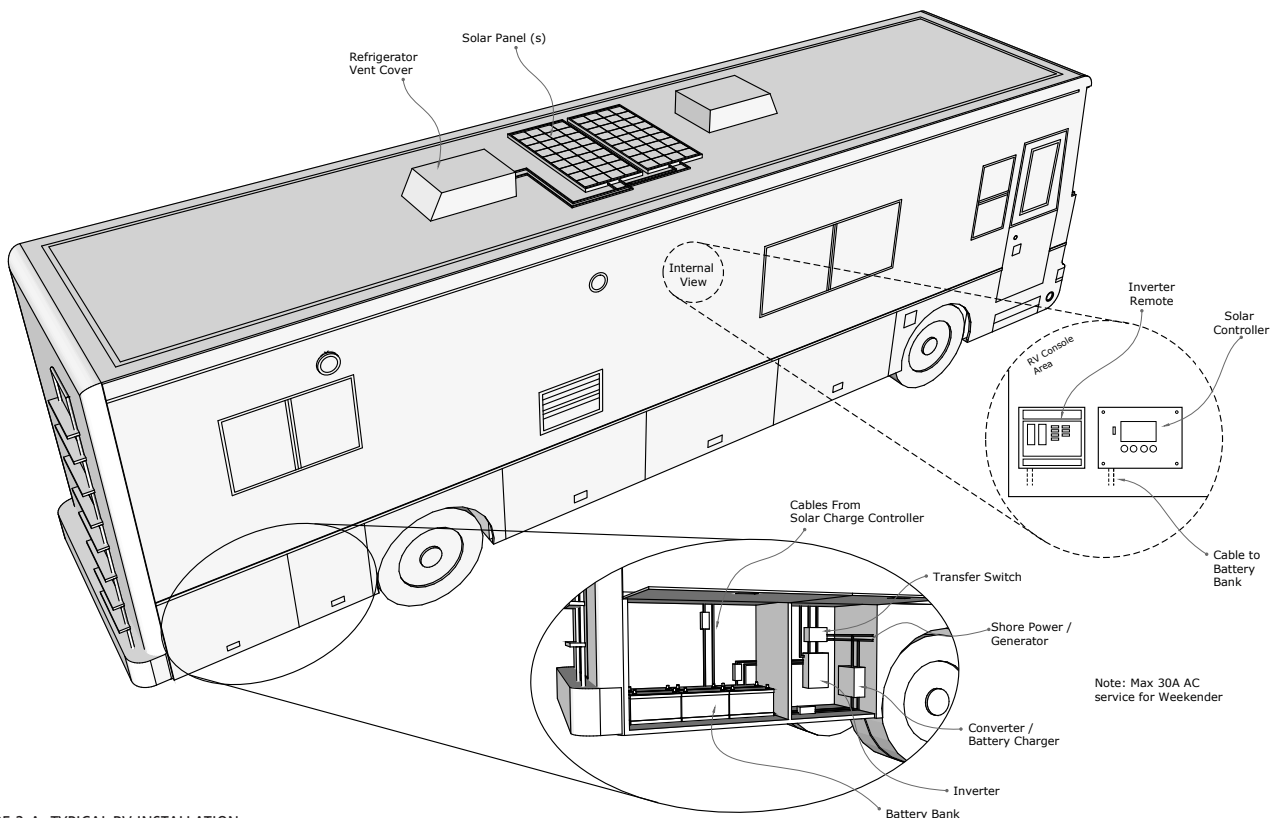

FIGURE 2-A: TYPICAL RV INSTALLATION

FIGURE 2-B: ECLIPSE 190 WIRING DIAGRAM

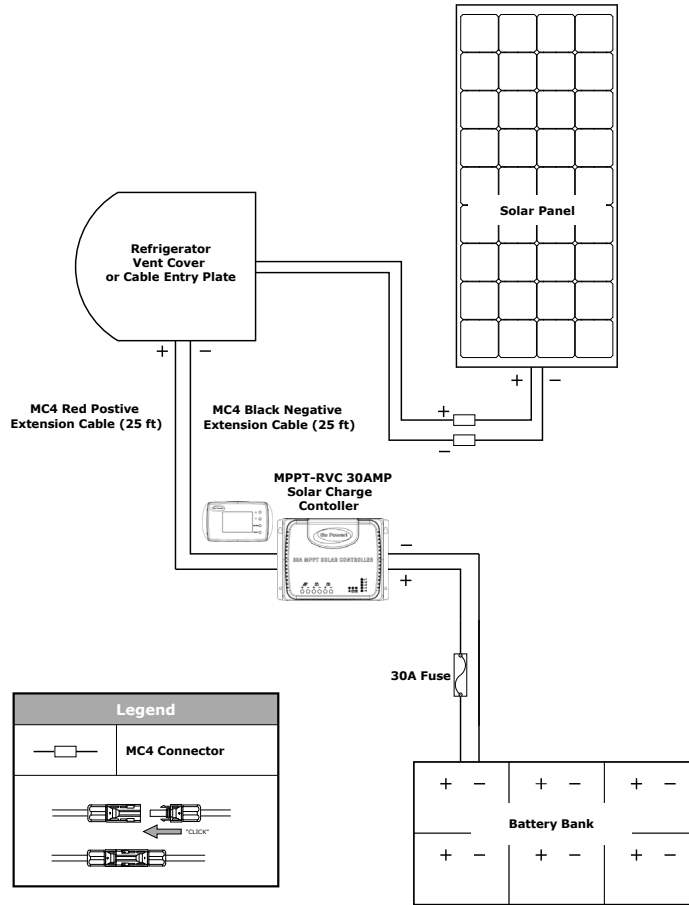
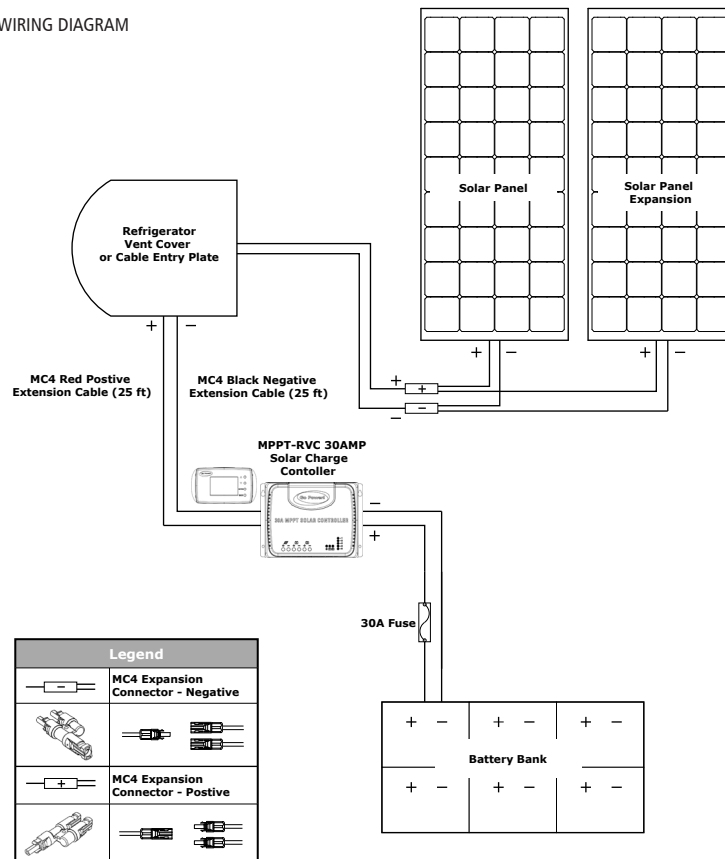

FIGURE 2-B: ECLIPSE 190 + EXPANSION WIRING DIAGRAM



2.2 CAUTIONS

Disconnect all power sources before attempting installation

Electricity can be very dangerous. Installation should be performed only by a licensed electrician or qualified personnel.



Solar panel safety

Photovoltaic panels generate DC electricity when exposed to sunlight or other light sources. Contact with the electrically active parts of the panel, such as terminals, can result in burns, sparks and lethal shock whether the panel is connected or disconnected.

When panels are connected in parallel, amperages are additive. Consequently, a system assembled from photovoltaic panels can produce high amperages, which constitute an increased hazard. Do not touch terminals while panel is exposed to light. Cover the panel face completely with opaque material to halt the production of electricity when installing or working with panels or wiring.



Battery and wiring safety

Observe all safety precautions of the battery manufacturer when handling or working around batteries. When charging, batteries produce hydrogen gas, which is highly explosive. Work in a well ventilated area and use caution when making or removing electrical connections. Ensure wires are disconnected from their power sources when wiring. Do not expose battery to open flame, cigarettes or sparks. Shield skin and eyes from battery acid.



Ensure all connections are tight and secure. Loose connections may generate sparks, heat and in extreme cases may catch fire. Be sure to check connections one week after installation to ensure they are still tight.



Work safely

Wear protective eye wear and appropriate clothing during installation. Use extreme caution when working with electricity and when handling and working around batteries. Use properly insulated tools only.



Observe correct polarity at all times

Reverse polarity of the battery terminals will cause the controller to give a warning tone. Reverse connection of the array will not cause an alarm but the controller will not function. Failure to correct this fault could damage the controller.



Do not exceed the voltage and current ratings of the Solar Controller

The total current of the solar system is the sum of the short circuit current of the solar panels in parallel, multiplied by a safety factor of 1.25. The resulting system current is not to exceed the amperage rating of the controller. The voltage of the array is the rated open circuit voltage of the solar panels and is not to exceed 28volts.

The current rating of the solar system is the sum of the Maximum Power Current (Imp) of the solar PV strings in parallel. The resulting system Imp current is not to exceed 30A. If your solar system exceeds these ratings, contact your dealer for a suitable controller alternative.



Observe AC service current requirements of the RV or boat

The Weekender kit is compatible with max 30A AC service. The Elite and Extreme kits are compatible with max 50A AC service.

2.3 DISCLAIMERS

IMPORTANT: Please follow installation and wiring instructions exactly as outlined to ensure safety. We recommend installation by an RV technician or professional electrician to ensure adherence to relevant electrical codes. We have made every reasonable effort to ensure the accuracy of the instructions in this manual, but Go Power! does not guarantee that the information is error free, nor do we make any other representation, warranty or guarantee that the information is accurate, correct, reliable or current. The specifications in this manual are for reference purposes only and are subject to change without notice. For additional information please see www.gpelectric.com.



DISCLAIMER: Go Power! disclaims liability for any direct, indirect or incidental damages caused by, or in case of, installation not performed following the instructions and cautions in this manual. Go Power! will refuse requests for exchanges or returns, resulting from the purchase and installation of items which do not comply with local codes. To avoid such concerns Go Power! recommends installation by a professional electrician or RV technician. Examples that are shown within this manual are for illustrative purposes only.

2.4 KIT PARTS

Note

Please unpack and make sure all parts shown in the list below are included in the kit. If any parts are missing please contact the Go Power! customer service team at customersupport@gpelectric.com or 1.866.247.6527.

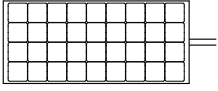
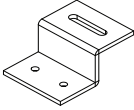
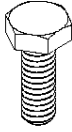
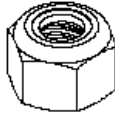
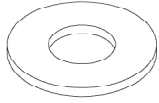
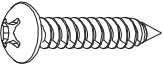
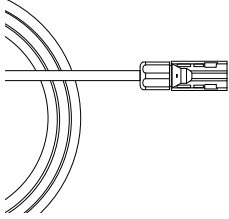
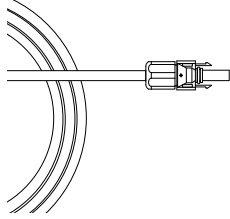
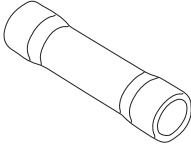
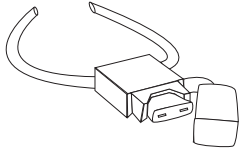
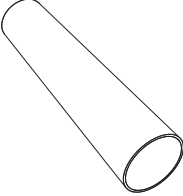
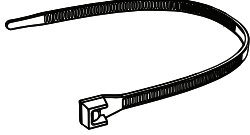
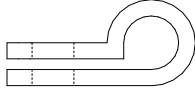
ITEM #	DESCRIPTION	ECLIPSE	ECLIPSE-E
01	Solar panel (Rigid OR Flex)	1	1
02	Solar panel mounting feet	4	4
03	1/4" bolt	4	4
04	1/4" lock nut	4	4
05	1/4" washer	8	8
06	#10-16 x 1" screw	8	8
07	#6 x 3/4" screw	6	
08	MC4 Black Negative Wire Extension Cable (25 ft)	1	
09	MC4 Red Positive Wire Extension Cable (25 ft)	1	
10	Butt Splice, 12-10 AWG	2	
11	Fuse Holder	1	
12	30A Fuse	1	
13	Heat Shrink	2	
14	Tie Wrap	6	
15	Cable Clamp	6	
16	Ring Terminal	2	
17	MPPT 30 Amp Solar Charge Controller	1	
18	Solar Controller Remote	1	
19	MC4 Expansion Connector (1 Male, 2 Female)		1
20	MC4 Expansion Connector (2 Male, 1 Female)		1

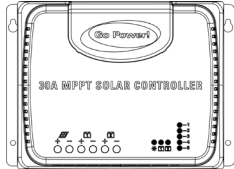
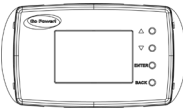
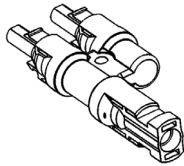
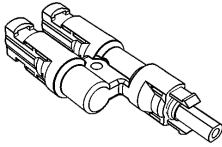
 <p>1</p>	 <p>2</p>	 <p>3</p>	 <p>4</p>	 <p>5</p>
 <p>6, 7</p>	 <p>8</p>	 <p>9</p>	 <p>10</p>	 <p>11, 12</p>
 <p>13</p>	 <p>14</p>	 <p>15</p>	 <p>16</p>	 <p>17</p>
 <p>18</p>	 <p>19</p>	 <p>20</p>		

2.5 TOOLS REQUIRED

<ul style="list-style-type: none">a. Screwdriver (Phillips)b. Keyhole Sawc. Pencil or Markerd. Plierse. Wire Strippers and Cuttersf. Butt Splice Crimping Toolg. Electric Hand Drill	<ul style="list-style-type: none">h. 1/16" and 3/8" Drill Bitsi. 5/16" & 7/16" Wrenchj. Heat Gunk. Caulking Gunl. Sealantm. Digital Multimeter (troubleshooting only)n. Torque Driver (optional)
--	--

Design your solar set up here:

3.1 PLAN YOUR SOLAR SYSTEM SETUP

1. Take a few minutes before commencing any installation work to layout your solar system on paper first. Use the diagrams within this manual (pages 20-27) to help.
2. Complete a simple block diagram identifying the key components and connections of your Solar charging system: Solar Panels, MC4 Positive and Negative Extension Cables, GP-RVC-30-MPPT Solar Charge Controller and your Battery Bank as detailed in the diagrams.
3. For the **Elite and Extreme Kits** include the Inverter, Charger/Converter and Transfer Switch. For detailed installation of these system components see the specific manuals included with each item.
4. Identify and prepare easy/safe access to possible installation locations in the 3 key installation areas within your RV;
 - **Roof** Solar Panels
 - **Instrument/Controls** Solar Charge Controller and/or Inverter Remote
 - **Storage Compartments** Inverter, Converter/Charger, Transfer Switch
5. Identify on your RV if you have a **Cable Entry Plate (CEP)** see Fig 3-A pre-installed by the RV Manufacturer. The Cable Entry Plate makes the Solar Panel to Solar Charge Controller installation simpler. (After market purchase of GP-CEP available)
6. If you do not have the Cable Entry Plate pre-installed on your RV, you will be following the 'Routing Power Cable through the Refrigerator Vent' steps.
7. Whilst on the roof of your RV identify the refrigerator vent and investigate the vent-fastening hardware.

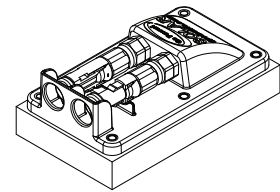

FIGURE 3-A: CEP

3.2 PLACEMENT OF SOLAR PANELS

1. Remove all solar panels from their boxes. Set aside the boxes as they will be used in the instructions to follow.
2. Using the solar panel boxes, plan the layout of the panels on your RV rooftop. Once you have positioned the boxes

Note

- Placement of the panel(s) should be as close together as possible. Each panel has 3.3' of cable coming from the junction box. It may be necessary to use solar panel extension cables. If required, longer extension cables can be purchased. Please contact customer service at 1.866.247.6527 to purchase.
- Select a location where the mounting surface is at least 1/2" thick and strong enough to support the solar panel mounting hardware.
- Solar panels should be located a minimum of 3' from the front of RV to reduce wind load on the panels.
- Avoid internal wiring when selecting the solar panel mounting locations for drilling the mounting holes.
- Ensure fixed obstacles, such as air conditioners, will not shade the solar panels. (Shading can greatly reduce the performance of the solar system).
- Ensure there is enough room to access the panels and other fixed obstacles for future inspection and maintenance.

3.3 LOCATING THE GP-RVC-30-MPPT 30 AMP SOLAR CHARGE CONTROLLER

1. The GP-RVC-30-MPPT is included in the Go Power! Eclipse RV Solar Kits detailed in this manual. The GP-RVC-30-MPPT provides the necessary protection for the RV battery system. A condensed version of the installation instructions appear in this manual. However, please read the full installation manual included with the GP-RVC-30-MPPT Solar Charge Controller.
2. Plan where the GP-RVC-30-MPPT solar charge controller will mount, see Figure 3-B.

Note

- The GP-RVC-30-MPPT is designed to be mounted vertically in an indoor location inside a weatherproof enclosure.
- Ideally the GP-RVC-R should be located so it can be easily seen for monitoring system operation. Locate at eye level (the backlit LED affects viewing angle)
- The location will need access to the cable ends from the solar panels and the battery compartment.



WARNING: Failure to secure the GP-RVC-30-MPPT could cause it to become dislodged while the RV is in transit and cause severe damage to the unit and/or the RV.

FIGURE 3-B

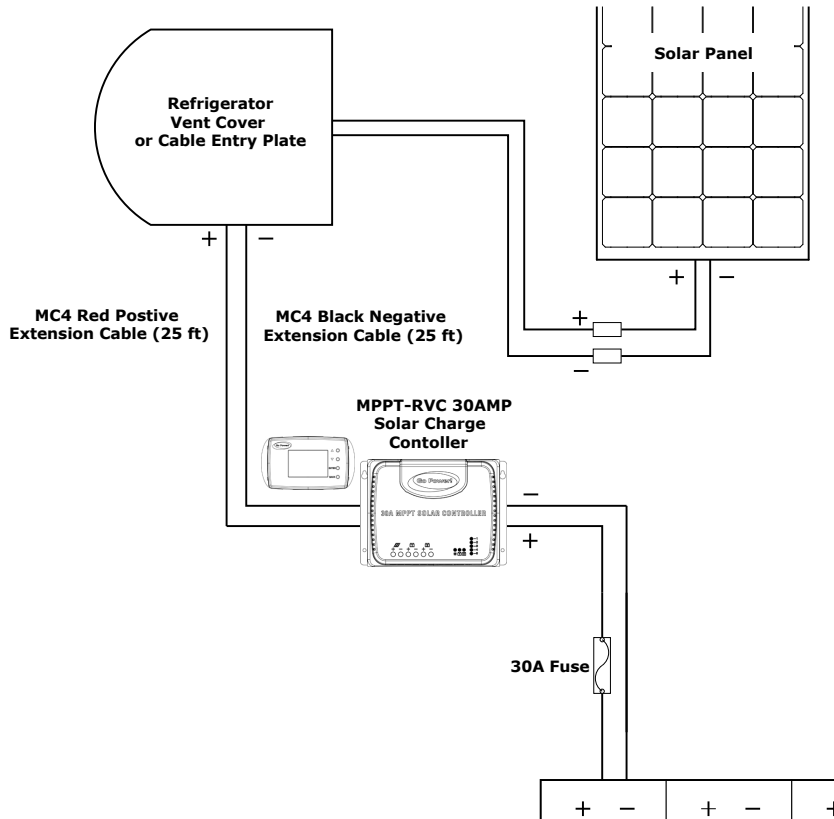

4.1 SOLAR PANELS



WARNING: Photovoltaic panels generate DC electricity when exposed to sunlight or other light sources. When exposed to light, contact with the electricity active parts of the panel, such as terminals, can result in burns, sparks and lethal shock whether the panel is connected or disconnected.

Do not touch the terminals while the panel is exposed to light. Cover the panel faces completely with an opaque material to stop the production of electricity when working with panels or wiring – the cardboard shipping boxes are the perfect option to cover glass surface of the panels.

Note Panels are not recommended to bend beyond 30° (for 100W Modules, 30° = 2.7", 69mm Bend)

Site Considerations — Excluded Operating Environments

Certain extreme operating environments are not recommended for Go Power! products and are excluded from the Go Power! limited warranty. These include (but are not limited to): winds exceeding 45 MPH, flooding or immersion in water or other fluids, contact with liquids or substances with a pH less than 6.5 or greater than 8.5, and contact with fire, projectiles, lava flow, volcanic eruptions, or meteors.

Mounting Configurations

Modules installed over a roofing system must be mounted over a flat, fire-resistant roof covering with the appropriate safety rating for the application. While modules can be mounted at any vertical or horizontal angle, it is recommended that they are installed at a minimum 10-degree angle to reduce dirt accumulation and soiling.



WARNING: Do not install panels on a surface that is not fire resistant or that can be damaged by high temperatures. These panels are designed to not catch fire themselves but can get hot during normal operation and excessively hot in some failure conditions such as cracked cells or failed protection diodes. Go Power! is not responsible for

heat damage such as discoloration, holes or fire due to improper installation.

Water entering the junction box could present a safety hazard, and junction boxes should be oriented on the uppermost position of the panel. The junction box should never be mounted in a depression. Note the junction box manufacturer rates this product with an ingress protection rating of IP67 for the box.

Modules may be attached using an adhesive on the panel backside or by using the grommet holes as attachment points. Go Power! does not recommend a preferred attachment method or make any claim as to the safety of the attachment.

Mount modules away from obstructions such as vents, AC Units, etc.

Module Handling

Always use gloves when handling modules. Modules are sensitive to oils and abrasive surfaces — not doing so may lead to scratching and soiling. Minimize module contact as much as possible, especially with any abrasive surfaces. Do not place anything on the modules. Do not lift modules by the cables or the junction box under any circumstances. Remove fingerprints from the panels by washing the panel as described below.

The panels are designed to withstand a 30-degree bend top to bottom (with the junction box placed on the top end) — approximately 8cm of deflection. Care must be taken not to bend, flex, or twist panels excessively when handling. Do not place sharp objects on the panels — this may cause a puncture or damage, resulting in decreased power and creating a potential safety hazard.

Do not use blunt or sharp force with other hardware (junction boxes, cables and connectors). The resulting damage could render the module unusable.

1. REMOVE shipping plastic from panel
2. Expose the panel(s) to sunlight and use a voltmeter to test for DC Voltage
3. Locate the solar panels on the RV roof replacing each of the boxes used in the planning step.
4. Locate the Cable Entry Plate / Fridge Vent or Access Point on the roof.
5. Attached the MC4 Positive and Negative Extension Cables to the solar panel (s).
6. Test that the end solar panel cables can reach the CEP / Fridge Vent Access Point.
7. Use the screws provided in the kit to secure the 4 solar panel mounting feet to the RV.
8. Apply sealant under and around each of the 4 mounting feet to ensure a watertight installation.



WARNING: All 4 mounting feet must be securely fastened to the RV roof. Failure to do so could cause the panels to lift and separate from the RV while in transit which could cause significant damage and/or injury.

Note Use appropriate sealant as recommended by your RV Dealer for your RV roof.

Electrical Connections

The connectors used in these panels allows for modules to be connected in series or parallel.

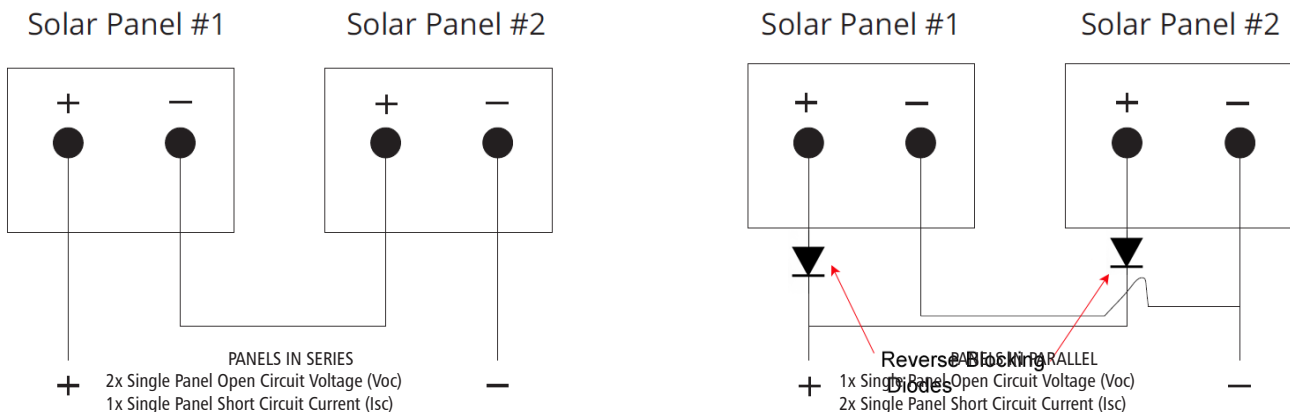

FIGURE 4-A

SERIES CONNECTION:

Connecting the panels in series increases the voltage of the system, so the two panels produce double the voltage as compared to one panel.



WARNING: Three or more series connected panels can produce voltages in excess of 60V DC which is considered to be high voltage and an increased safety hazard.

To connect panels in series, connect the negative (-) plug of panel #1 to the positive (+) plug of the panel #2. See Figure 4-A left.

PARALLEL CONNECTION:

Connecting the panels in parallel increases the current of the system, so the two panels produce double the current as compared to one panel. It is recommended that reverse blocking diodes be used on the positive lead of each module connected in parallel to prevent damage and unsafe conditions.



WARNING: If shading occurs without additional electronic components, such as a reverse blocking diode, the bypass diode inside the junction box may be damaged leading to further panel damage and unsafe conditions including extreme temperatures.

WARNING: When panels are connected in parallel, currents are additive. Consequently, a system assembled from photovoltaic panels can produce high amperage, which constitute an increased hazard.

To connect panels in parallel, connect the positive (+) plug of panel #1 to the positive (+) plug panel #2. Connect the negative (-) plug of panel #1 to the negative (-) plug of panel #2. See Figure 4-A Right. In this configuration, cable adapters will be needed.

4.2 REFRIGERATOR VENT ACCESS - OPTION 1

1. Locate the refrigerator vent on the roof of the RV. Remove vent cover to gain access to the duct opening.
2. Drill a hole through the side of the vent (5/8" hole).
3. Remove any sharp edges from the hole.
4. Insert a rubber grommet (not included) into the hole.
5. Insert the MC4 Positive and Negative Extension Cables through the hole and carefully route it to the GP-RVC-30-MPPT Solar Charge Controller. Be certain to leave enough slack to allow cable routing from module to vent along desired path.
6. Use cable clamps with the #6 self-tapping screw and/or tie wraps every few feet along RV roof and interior route to the GP-RVC-30-MPPT Solar Charge Controller.
7. Ensure all penetrations into the RV roof are watertight. Use an appropriate sealant as recommended by your RV Dealer to seal holes wherever necessary.
8. Replace vent cover.

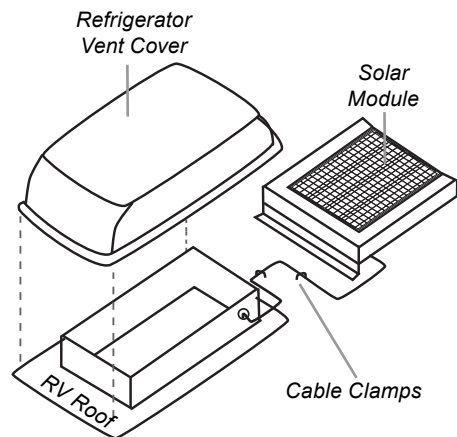

Caution: The drilled hole may have sharp edges or burrs - REMOVE

FIGURE 4-B

ever necessary.

4.3 REFRIGERATOR VENT ACCESS - OPTION 2

1. Locate the refrigerator vent on the roof of the RV. Remove vent cover to gain access to the duct opening.
2. Thread MC4 Positive and Negative Extension Cables carefully through the screen and into opening.
3. Enlarge screen grid hole if necessary.
4. Remove any sharp edges from the hole.
5. Avoid strapping the power cable to existing wire between the

Note

le and the battery. Allowing a few inches of space between the power cable and existing wire will lessen the chance of voltage loss through thermal conduction.

6. Use cable clamps with the # 6 self-tapping screw and/or tie wraps every few feet along RV roof and interior route to the GP-RVC-30-MPPT Solar Charge Controller.
7. Ensure all penetrations into the RV roof are watertight. Use an appropriate sealant as recommended by your RV Dealer to seal holes wherever necessary.

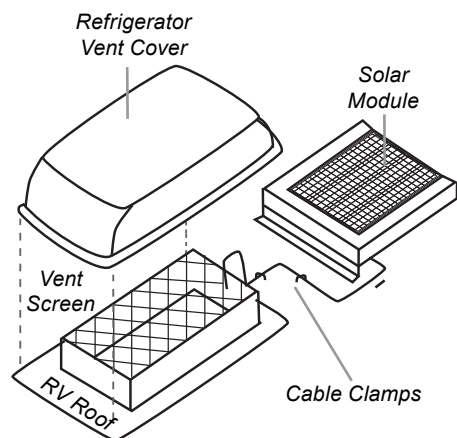

Caution: The vent screen may have sharp edges or burrs.

FIGURE 4-C

8. Replace vent cover.

4.4 CABLE ENTRY PLATE - OPTION 3

1. Remove the rubber sealing caps from the ends of the MC4 connectors in the CEP.
2. Plug the Positive and Negative MC4 Connectors from the solar panels directly into the CEP.
3. Locate the positive and negative cables exiting the CEP and route these to the GP-RVC-30-MPPT Solar Charge Controller

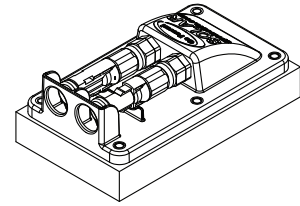

FIGURE 4-D

4.5 MOUNTING FEET

4. Assemble 4 mounting feet onto each of the solar panels frame using the 1/4" bolts and nuts. This assembly is easily completed on the ground before the panels are brought up to the RV roof. (See Figure 4-A)



WARNING:

- The mounting feet must be installed on the 4 outer holes in the panel frame.
- All 4 mounting feet must be used on a solar panel.
- The mounting surface must be at least 1/2" thick and strong enough to support the solar panel mounting hardware.

5. Tighten the nuts securely using a 7/16" wrench.

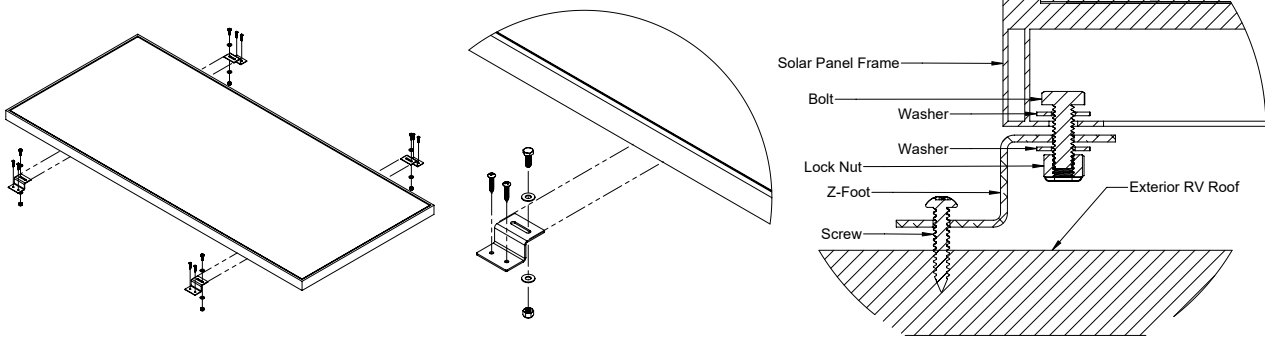

FIGURE 4-A: SOLAR PANEL INSTALLATION DETAILS

4.6 INSTALLING THE SOLAR CHARGE CONTROLLER



Ensure the Solar Panels are covered. Cover the panel faces completely with an opaque material to stop the production of electricity when working with panels or wiring – the cardboard shipping boxes are the perfect option to cover glass surface of the panels.

1. Use the templates included in the GP-RVC-30-MPPT and GP-RVC-R Manuals to mark the four mounting holes and the "cutting line for flush mounting".
2. Drill the mounting holes
3. Use a keyhole or jig saw to cut along the rectangular outline previously marked
4. Cut the MC4 extension cables to length, allow some excess for strain relief/flexibility
5. Use the leftover cable to connect the controller to the batteries ensuring the 30A Fuse is installed as per 4.7. If extra battery cable is required to connect to the battery bank, Go Power! recommends using an equivalent cable to that supplied with the kits: 10 Gauge Wire rated to – UL/CUL/USE2.
6. Mount the controller to the wall using the four wood screws provided.
7. Ensure the back of the controller is protected from damage by any object

4.7 INSTALLING THE 30A FUSE AND FUSE HOLDER

1. Locate the positive battery cable from the GP-RVC-30-MPPT.
2. Plan where you can safely and easily access the fuse holder & fuse.
3. Cut the battery positive cable from the GP-RVC-30-MPPT to the planned lengths.
4. Strip the fuse holder cable and positive cable from GP-RVC-30-MPPT as shown in Fig 4-F.
5. Thread the red heat-shrink onto the fuse holder cable
6. Insert the fuse holder and GP-RVC-30-MPPT-stripped cable ends into the butt splice as shown in Fig 4-G.
7. Crimp the butt splice fully - test the connection by gently pulling on both cables.
8. Thread the heat-shrink over the butt splice as shown in Fig 4-H.
9. Use the heat gun to shrink the heat shrink over the butt as shown in Fig 4-I.
10. Repeat the process for the other fuse holder cable & battery connection.
11. Do not install the 30A Fuse at this stage.

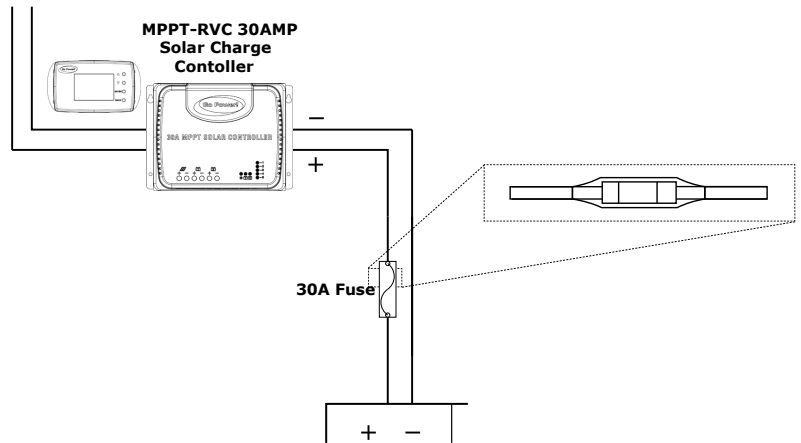

FIGURE 4-E

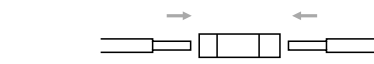

FIGURE 4-F

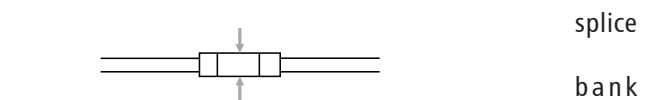

FIGURE 4-G

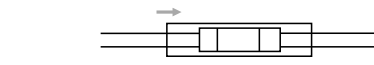

FIGURE 4-H

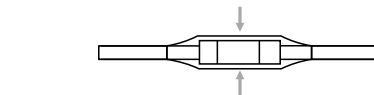

FIGURE 4-I

4.8 CONNECT THE SOLAR CHARGE CONTROLLER TO THE BATTERY BANK

It is recommended to connect directly to the battery whenever possible. You can also connect to the converter/charger where the battery positive and negative wires connect to the converter/charger

1. Clean all corrosion from the battery terminals before proceeding
2. Crimp ring terminals onto the positive and negative cables to be attached to the battery
3. Check the ring terminal crimp connection by gently pulling on the cable and ring terminal
4. Attach the Negative (Black) ring terminal to the battery bank and tighten according to the battery manufacturers specification
5. Attach the Positive (Red) ring terminal to the battery bank and tighten according to the battery manufacturers specification
6. Check all electrical connections
7. Apply a protective coating to the battery terminals

4.9 INITIAL CONNECTION AND OPERATING

1. Check all electrical connections and ensure all cables are securely fastened
2. Install the Fuse into the fuse holder, ensure the fuse holder is securely fastened

3. Remove the opaque material from the solar panels
4. Follow the solar charge controller user manual and operating steps

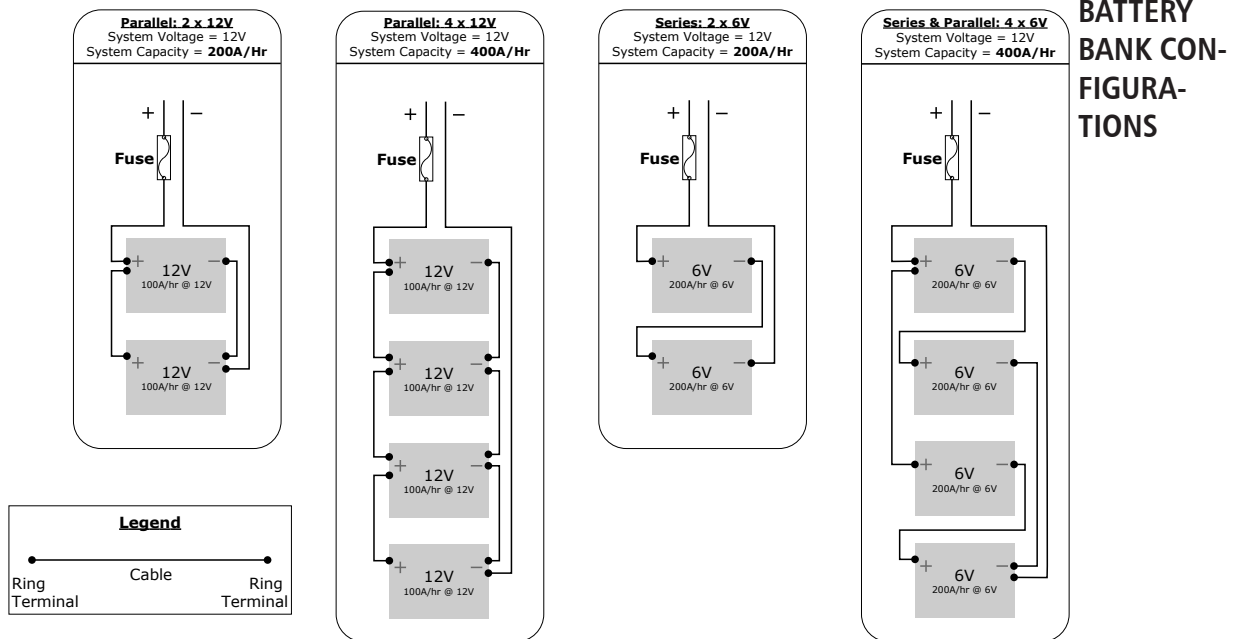

FIGURE 4-J: TYPICAL BATTERY BANK CONFIGURATIONS

5. MAINTENANCE

5.1 INSPECTION

After installing any Go Power! Solar Kit or any other Go Power! products, all modules, electrical and mechanical components and connections should be inspected annually by a trained Go Power! or dealer representative or other qualified personnel for safe electrical and mechanical connections and to ensure modules are corrosion-free and vehicle mounting has not affected connections.

5.2 CLEANING

Although Go Power! Solar Kits are generally maintenance free, significant performance gains can be made with clean solar panels

1. Clean the solar panels monthly. Use water and a soft sponge or cloth. A mild non-abrasive cleanser can be used for more stubborn residue. Rinse well.
2. Clean solar panels more frequently during drier months, as they may become covered in dust more quickly. A pressure washer is not recommended.
3. Visual inspection – check the exterior for cracks, missing or broken hardware or other potential problems. Check all roof penetrations and replace sealant areas as required

5.3 LONG TERM STORAGE - RV

If your RV will be stored in extremely cold climates you may need to remove your batteries to prevent them from freezing. Please note [page 16] | gpelectric.com

6. WARRANTY



if your solar panel(s) are covered by snow they will not produce power and can not be depended upon to keep the batteries topped up. In mild climate storage you can depend upon your solar system to top up your batteries when they are exposed to sunlight. Make sure that all parasitic draws are removed from the batteries i.e. Propane detector, clock radio, etc to make sure the solar panel(s) can keep the batteries topped up even with reduced sun exposure.

6.1 WARRANTY LENGTH

The Go Power! warranty is valid against defects in materials and workmanship for the specific product warranty period. It is not valid against defects resulting from, but not limited to:

- **Misuse and/or abuse, neglect or accident**
- **Exceeding the unit's design limits**
- **Improper installation, including, but not limited to, improper environmental protection and improper hook-up**
- **Acts of God, including lightning, floods, earthquakes, fire, and high winds**
- **Damage in handling, including damage encountered during shipment**

A warranty shall be considered void if the warranted product is in any way opened or altered. The warranty will be void if any eyelet, rivets, or other fasteners used to seal the unit are removed or altered, or if the unit's serial number is in any way removed, altered, replaced, defaced, or rendered illegible.

6.2 Warranty Return Procedure

Before contacting Go Power!'s customer service department, please read the "frequently asked questions" section of our website to troubleshoot the problem. If trouble persists:

4. Call your Go Power!™ Technical Support team (1-866-247-6527) or
5. Return defective product to place of purchase

Unless approved by Go Power! Management, all product shipped collect to Go Power! will be refused. Test items or items that are not under warranty, or units that are not defective, will be charged a minimum bench charge of (\$50.00 US) plus taxes and shipping. A 15% restocking charge will be applied on goods returned and accepted as "new" stock.

An RMA number (Return Materials Authorization number) from Go Power! Customer Service is required prior to returning any Go Power!. Go Power! reserves the right to refuse any items sent to Go Power! without an associated RMA number. To obtain an RMA number, please contact techsupport@gpelectric.com or Telephone 1-866-247-6527 or Fax 1-866-607-6527 worldwide.

Out of Warranty

Go Power! electronic products are non-repairable, Go Power! does not perform repairs on its products nor does it contract out those repairs to a third party. Go Power! does not supply schematics or replacement parts for any of its electronic products.

© 2021 Go Power!

Worldwide Technical Support and Product Information gpelectric.com

Go Power! | Dometic

201-710 Redbrick Street Victoria, BC, V8T 5J3

Tel: 1.866.247.6527

MAN_ECLIPSE_190W_RevA-DOMPGP

